

# SULLY - 651SX CW

650SX - LED 115 W



- **Type:** Profile spot
- **Source:** LED 115 W
- **Optics:** 11° to 26° zoom  
11° to 26° configuration possible
- **Colour temperature:** Cool White

Profile spot

## The new classic theatre zoom profile in LED version

The Sully 650SX Series is a variable zoom profile range featuring a high-quality 115 W cool white LED source that delivers a first-class white light and an output that exceeds a 2500 W tungsten luminaire equipped with CTB filter. Combining this new LED engine with the proven optics of the renowned 600SX Series, Sully profile offers accurate framing and superb gobo projection. The LED compartment of the Sully profile can be swapped with those of the 600SX Series (as well as with those of Aledin 630SX or Quincy 420SX Series). It is equally happy on stage, overhead, on side booms or prosceniums, in opera houses, theatres and studios, where "daylight" rendering is required.

### Features

- **Multi-function double gate:** simultaneous use of gobos and iris. Sharp focus of both gobo and shutter
- **Shutter gate:** up to 8 shutters. Remove shutters for easy maintenance or tuck fully inside gate for secure transport
- **User-friendly shutter-lock system:** secures shutters' setting in any circumstances (locking efficient up to 4 shutters)
- **Universal gobo holder:** "A" size glass and metal gobo
- **Lens tube lock feature:** secures rotating lens tube against unwanted movement
- **90° rotating lens tube / gate / front accessories holder:** rotation of the projected image is always possible – no need to move the yoke
- **Internal glass filter holder:** long term use of durable coloured, dichroic or textured glass
- **Adjustable response time:** choice of fast or slow dimming for tungsten-like simulation - adjustment by DMX protocol
- **Ethernet-DMX node:** data IN through RJ45 connector; data OUT through DMX for daisy chaining
- **Universal data control:** compatible with DMX, RDM, Art-Net, sACN protocols
- **Remote setup:** all parameters can be adjusted by RDM protocol or by web interface
- **PWM adjustment:** choice of different PWM dimming frequencies - continuous mode available
- **DMX:** 8 or 16 bit dimming and strobe function
- **Dimming parameters:** choice of square or linear dimming curves
- **Local setup (optional):** dMX address and mode, dimming curve and response time through 4-button display with automatic light switch-off
- **Easy focus reference:** graduated scale on side of the unit; fast and easy refocusing
- **Tilt reference on hanging yoke:** index for rapid re-positioning

### Optical

- **Long life:** outstanding operational lifetime expectation, no need to replace lamps, low maintenance
- **Choice of colour temperature:** warm or cool white LED compartment can be easily swapped
- **SX optical system:** double condenser optics for exceptional optical quality
- **Optional coated double condenser optics:** up to 15% more light output
- **Variable zoom optics:** sharp focus at every beam angle. Independent control of image size and focus. Focus handles on both sides
- **Electronic dimmer:** dimming without clipping or cut-out at low intensity levels; high quality smoothing
- **No colour shift:** colour temperature remains the same when dimming

### Construction

- **Made in France :** fully manufactured in Robert Juliat premises retaining complete control over all aspects of quality
- **Interchangeable lamp bases:** with 600SX (1000/1200 W tungsten) series
- **PSU:** built-in electronic flicker-free power supply for easy, plug-and-play installation
- **Power connectors:** neutriK® powerCON TRUE1 TOP IN and OUT connectors for daisy chaining
- **Silent-running cooling fans:** ideal for TV studios and opera houses
- **Electronic thermal management system:** ensures maximum performance of the system without any risk of overheating
- **Bodywork:** strong sheet metal construction for durability
- **Captive knobs and handles:** additional security when working at height or in transit
- **Spare parts and accessories:** interchangeable across the tungsten, discharge or LED ranges, reducing running costs
- **Easy access to all parts:** easy cleaning and maintenance

Picture:651SX

DSEN378\_651SX\_CW - 05/06/2023

Robert Juliat reserves the right to change or alter any of the items detailed on this page, to increase or improve manufacturing techniques without prior notice.

Robert Juliat S.A.S., 32 rue de Beaumont, 60530 Fresnoy-en-Thelle - France  
Telephone : +33 (0)3 44 26 51 89 - info@robertjuliat.fr - www.robertjuliat.com



ROBERT JULIAT

**Source** (Light quality report(s) available at the end of the document)

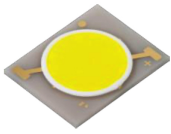

- **Lamp type:** LED
- **Power:** 115 W

LED specifications	Power *	Lumen output*	Colour temperature*	CRI*
LED 115W CW	115 W	14 300 lm	5700K	93

(\*) manufacturer's data

**Optics**

**Characteristics**

- **Type:** Zoom
- **Beam range:** 11° to 26°  
11° to 26° configuration possible
- **Focal length:** 197 - 415 mm

**Gel filter**

- **Shape:** Square
- **Standard size:** 180x180 mm (7.1x7.1 in)
- **Optional size:** 185x185 mm (7.3x7.3 in)

**Gobo**

- **Size:** A
- **Material:** Metal  
Glass



**Photometrics** (Photometrics report(s) available at the end of the document)

optics: 11°-26° / Standard

**• Optics @ 11°**

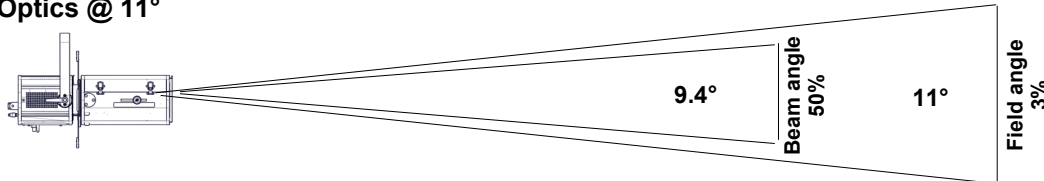

**Beam intensity**  
413 400 cd

**Field lumens**  
7 500 lm

**Efficacy**  
57 lm/W

<b>Distance</b>	5 m	10 m	15 m	20 m	25 m	30 m
<b>Diameter</b>	1 m	1.9 m	2.9 m	3.9 m	4.8 m	5.8 m
<b>Illumination</b>	17 000 lux	4 150 lux	1 850 lux	1 050 lux	670 lux	460 lux
<b>Distance</b>	15 ft	35 ft	50 ft	65 ft	80 ft	100 ft
<b>Diameter</b>	2.9 ft	6.7 ft	9.6 ft	12.5 ft	15.4 ft	19.3 ft
<b>Illumination</b>	1 850 fc	340 fc	170 fc	100 fc	65 fc	42 fc

**• Optics @ 26°**

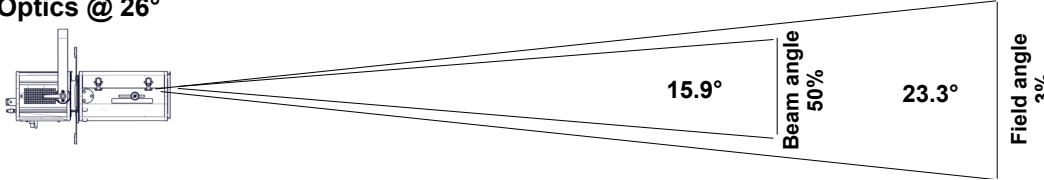

**Beam intensity**  
114 900 cd

**Field lumens**  
7 780 lm

**Efficacy**  
59 lm/W

<b>Distance</b>	5 m	10 m	15 m	20 m	25 m	30 m
<b>Diameter</b>	2.1 m	4.1 m	6.2 m	8.2 m	10.3 m	12.4 m
<b>Illumination</b>	4 600 lux	1 150 lux	520 lux	290 lux	190 lux	130 lux
<b>Distance</b>	15 ft	35 ft	50 ft	65 ft	80 ft	100 ft
<b>Diameter</b>	6.2 ft	14.4 ft	20.6 ft	26.8 ft	33 ft	41.2 ft
<b>Illumination</b>	520 fc	95 fc	46 fc	28 fc	18 fc	12 fc

**Remote control**

- **Data protocol:** USITT DMX512-A  
RDM / Art-Net / sACN

- **Data IN connector:** 5 pins XLR mâle + etherCON RJ45
- **Data OUT connector** 5 pins XLR femelle



**• DMX chart:**

Mode 1 (1 channels)	Mode 2 (2 channels)	Mode 3 (5 channels)	Mode 4 (6 channels)
Dimmer	Dimmer Dimmer fine	Dimmer Strobe duration Strobe speed Response time Control mode	Dimmer Dimmer fine Strobe duration Strobe speed Response time Control mode

## Dimensions and weight

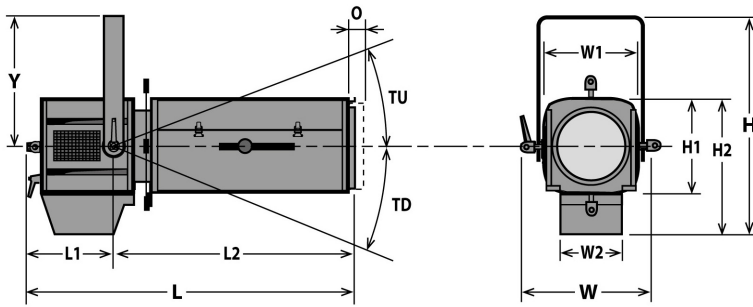

**Weight:** 13.9 kg (30.6 lbs)

Height	Length	Width	Yoke	Tilt	Option
H= 473 mm (18.6 in)	L= 782 mm (30.8 in)	W= 330 mm (13 in)	Y= 280 mm (11 in)	TU= 63°	O= 25 mm (1 in)
H1= 208 mm (8.2 in)	L1= 240 mm (9.4 in)	W1= 208 mm (8.2 in)		TD= 90°	
H2= 294 mm (11.6 in)	L2= 542 mm (21.3 in)	W2= 136 mm (5.4 in)			

## Shipping

- **Weight :** 16.8 kg (37 lbs)
- **Volume :** .13 m<sup>3</sup> (4.59 ft<sup>3</sup>)

## Installation

- **Minimum distance to illuminated surface:** 0.8 m ( 2.6 ft )
- **Operating position:**

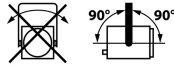

## Construction

- **Housing:** Steel sheet - Aluminium
- **Colour:** Black
- **Cooling:** Low noise variable fan
- **Maximum ambient temperature (Ta):** 40°C (104°F)
- **Maximum case temperature (Tc):** 52°C (125.6°F)
- **Total heat dissipation:** 444 BTU/h
- **Ingress Protection (IP) rating:** IP20

## Electrical compatibility

- 220/230 V - 50 Hz
- 245 V - 50 Hz
- 110/120 V - 60 Hz
- 208 V - 60 Hz
- 220/230 V - 60 Hz
- 100 V - 50 Hz
- 100 V - 60 Hz
- Selector: automatic detection

## Power input



- **Type:** removable power cord with Neutrik powerCON TRUE1 TOP connector (included)
- **Cable:** H07RNF 3G1.5
- **Length:** 3 m (9.8 ft)
- **Power connector:** CEE 7/7 (2P+E NF/Schuko)

## Power consumption

Voltage	Frequency	Current	Power	Power factor
230 V	50 Hz	0.7 A	130 W	0.81
120 V	60 Hz	1.15 A	135 W	0.98
100 V	60 Hz	1.4 A	135 W	0.96

## Power Supply Unit

- **PSU:** Internal - Electronic PSU - Flicker free with PFC
- **Control:** / DMX
- **Protection:** Mains: 2x 6.3A 5x20 T fuses /
- **Power thru:** Neutrik powerCON TRUE1 TOP - Maximum of 22 units (230 V) / 12 units (120 V)

## Warranty

- **Fixture: 3 years**  
See General Sales Condition on website

## Approvals









## Acoustics

- **Noise level:** < 22,8 dB(A)











## Model









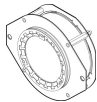
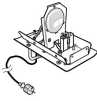
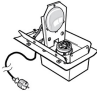

<b>651SX CW</b>	LED 115 W Profile spot - 651SX CW Sully - Cool White - 11/26°
-----------------	---

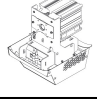
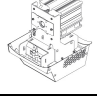
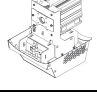
## Options

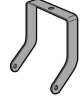
<b>CAV600E</b>	Double slot front cassette for 185x185mm accessories	
<b>CAV600</b>	Double slot front cassette for 180x180mm accessories	
<b>APH 68LEDM</b>	Double-condenser set for Led profile	
<b>PCP1716A</b>	16A blue 2P+E 6h IEC60309 power connector	
<b>FCD600PV</b>	Angled yoke	
<b>DISP2</b>	Display and keyboard for local setup	

## Accessories

<b>D8</b>	Shutter for SX series <b>4 included</b>	
<b>PF500M2</b>	180x180mm metal filter holder <b>1 included</b>	
<b>SGUX</b>	Universal "A" size gobo-holder (metal, glass, frosted glass) <b>1 included</b>	
<b>IWSX755</b>	Drop-in iris (monoplane) with holder - Poids: 0.26 Kg	
<b>D8</b>	Shutter for SX series	
<b>PF600M2</b>	185x185mm metal filter holder	
<b>G500</b>	180x180mm safety grid	
<b>CAV600A</b>	Double slot front cassette for 180x180mm accessories - Poids: 0.43 Kg	
<b>CAV600AE</b>	Double slot front cassette for 185x185mm accessories - Poids: 0.45 Kg	
<b>RPF613</b>	180x180mm front extension cassette for 215x215mm accessories without fan (recommended for dark colours on 613SX/663SX) - Poids: 1.5 Kg	
		

<b>RPF613E</b>	180x180mm front extension cassette for 245x245mm accessories without fan (recommended for dark colours on 613SX/663SX)	
<b>APH 68LED</b>	Double-condenser set for Led profile - Poids: 0.58 Kg	
<b>T/600SX</b>	Lamp compartment for 1000/1200W tungsten GX9,5 lamps - 3 meter power cable with CEE 7/7 (2P+T NF/SCHUKO) connector - Poids: 1.36 Kg	
<b>T/600VSX</b>	Lamp compartment for 1000/1200W tungsten G22 lamps with fan - 3 meter power cable with CEE 7/7 (2P+T NF/SCHUKO) connector - Poids: 2.03 Kg	
<b>T/650DSX4C</b>	SULLY 200W LED compartment with display - 4 colours - 3 meter power cable with CEE 7/7 (2P+T NF/SCHUKO) connector - Poids: 2.88 Kg	
<b>T/650DSXCW</b>	SULLY 115W LED compartment with display - Cool White - 3 meter power cable with CEE 7/7 (2P+T NF/SCHUKO) connector - Poids: 2.33 Kg	
<b>T/650DSXWW</b>	SULLY 115W LED compartment with display - Warm White - 3 meter power cable with CEE 7/7 (2P+T NF/SCHUKO) connector - Poids: 2.33 Kg	
<b>T/650SXWW</b>	SULLY 115W LED compartment - Warm White - 3 meter power cable with CEE 7/7 (2P+T NF/SCHUKO) connector - Poids: 2.27 Kg	
<b>VD120</b>	120x120mm frosted glass	
<b>FCD600</b>	Angled yoke	
<b>TH600</b>	180x180mm "Top hat" (without safety cable) - ø150mm / 150mm long	
<b>DMXcat</b>	Bluetooth DMX/RDM Multifunction test tool - City Theatrical DMXcat®	
<b>876</b>	Hook clamp 40x10mm with 28mm M10 screw for Ø35 to 50mm pipes - SWL: 50Kg - Poids: 1.25 Kg	
<b>880</b>	Hook clamp 40x10mm with 28mm M10 screw for Ø50 to 63mm pipes - SWL: 50Kg - Poids: 1.36 Kg	
<b>CS2</b>	Safety cable Ø3 mm L= 600mm - SWL: 75 Kg	

• Optics @ 11°

Field lumens	Beam lumens	Efficacy	Beam intensity	CCT	Delta uv
7 500 Lm	6 230 Lm	57 Lm/W	413 400 Cd	5 430 K	0.0043

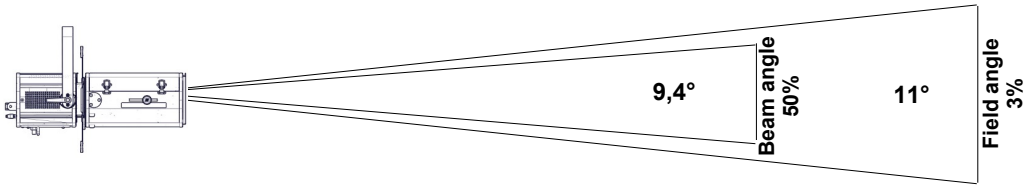

Distance	5 m	10 m	15 m	20 m	25 m	30 m
Field diameter	1 m	1,9 m	2,9 m	3,9 m	4,8 m	5,8 m
Illumination	17 000 lux	4 150 lux	1 850 lux	1 050 lux	670 lux	460 lux
Distance	15 ft	35 ft	50 ft	65 ft	80 ft	100 ft
Field diameter	2,9 ft	6,7 ft	9,6 ft	12,5 ft	15,4 ft	19,3 ft
Illumination	1 850 fc	340 fc	170 fc	100 fc	65 fc	42 fc

• Optics @ 19°

Field lumens	Beam lumens	Efficacy	Beam intensity	CCT	Delta uv
7 520 Lm	6 230 Lm	57 Lm/W	177 700 Cd	5 420 K	0.0044

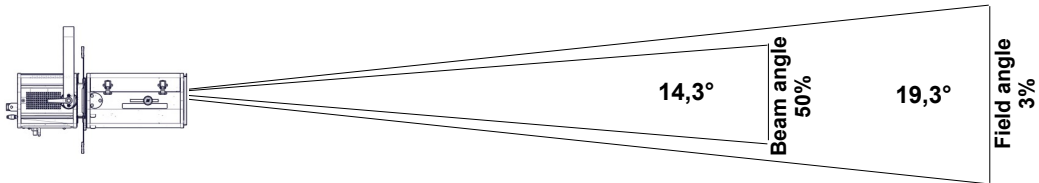

Distance	5 m	10 m	15 m	20 m	25 m	30 m
Field diameter	1,7 m	3,4 m	5,1 m	6,8 m	8,5 m	10,2 m
Illumination	7 200 lux	1 800 lux	790 lux	450 lux	290 lux	200 lux
Distance	15 ft	35 ft	50 ft	65 ft	80 ft	100 ft
Field diameter	5,1 ft	11,9 ft	17 ft	22,1 ft	27,2 ft	34 ft
Illumination	790 fc	150 fc	75 fc	43 fc	28 fc	18 fc

• Optics @ 26°

Field lumens	Beam lumens	Efficacy	Beam intensity	CCT	Delta uv
7 780 Lm	6 300 Lm	59 Lm/W	114 900 Cd	5 410 K	0.0044

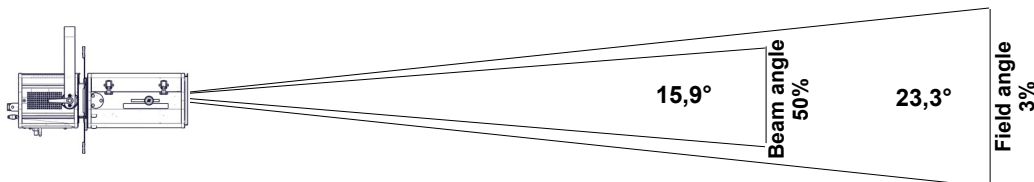

Distance	5 m	10 m	15 m	20 m	25 m	30 m
Field diameter	2,1 m	4,1 m	6,2 m	8,2 m	10,3 m	12,4 m
Illumination	4 600 lux	1 150 lux	520 lux	290 lux	190 lux	130 lux
Distance	15 ft	35 ft	50 ft	65 ft	80 ft	100 ft
Field diameter	6,2 ft	14,4 ft	20,6 ft	26,8 ft	33 ft	41,2 ft
Illumination	520 fc	95 fc	46 fc	28 fc	18 fc	12 fc

• Optics @ 11°

Field lumens	Beam lumens	Efficacy	Beam intensity	CCT	Delta uv
8 510 Lm			436 900 Cd	5 530 K	

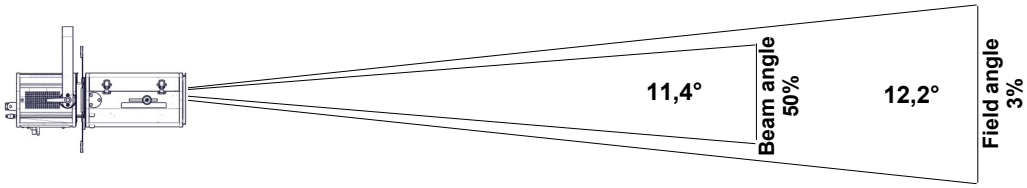

Distance	5 m	10 m	15 m	20 m	25 m	30 m
Field diameter	1,1 m	2,1 m	3,2 m	4,3 m	5,3 m	6,4 m
Illumination	17 500 lux	4 400 lux	1 950 lux	1 100 lux	700 lux	490 lux
Distance	15 ft	35 ft	50 ft	65 ft	80 ft	100 ft
Field diameter	3,2 ft	7,5 ft	10,7 ft	13,9 ft	17,1 ft	21,4 ft
Illumination	1 950 fc	360 fc	180 fc	110 fc	70 fc	44 fc

• Optics @ 26°

Field lumens	Beam lumens	Efficacy	Beam intensity	CCT	Delta uv
8 750 Lm			125 800 Cd	5 440 K	

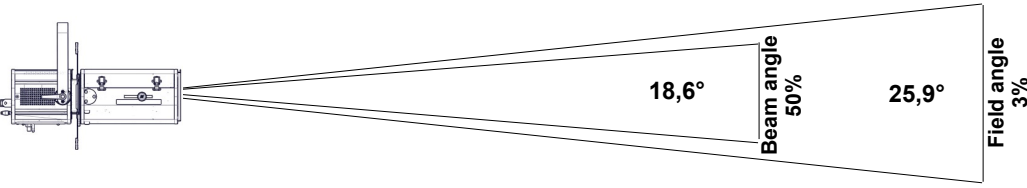

Distance	5 m	10 m	15 m	20 m	25 m	30 m
Field diameter	2,3 m	4,6 m	6,9 m	9,2 m	11,5 m	13,8 m
Illumination	5 100 lux	1 300 lux	560 lux	320 lux	210 lux	140 lux
Distance	15 ft	35 ft	50 ft	65 ft	80 ft	100 ft
Field diameter	6,9 ft	16,1 ft	23 ft	29,9 ft	36,8 ft	46 ft
Illumination	560 fc	110 fc	55 fc	30 fc	20 fc	13 fc

# Light quality report

CCT	DeltaUV	CRI Ra	CRI R9	CQS Qa	TM30-18 Rf	TM30-18 Rg	TLCI	SSI [D5042]
5 040K	0.0044	93	58	93	92	102	89	73

## CRI - CIE Colour Rendering Index

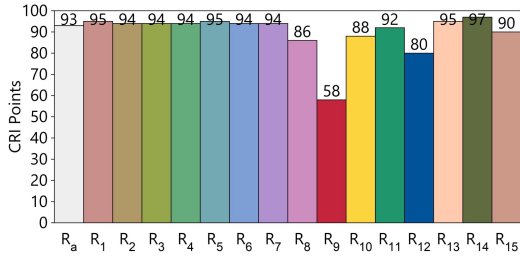

## TLCI - Television Lighting Consistency Index

Test : CCT = D5042 (+0.2)  
 TLCI-2012 : 89 (D5042)

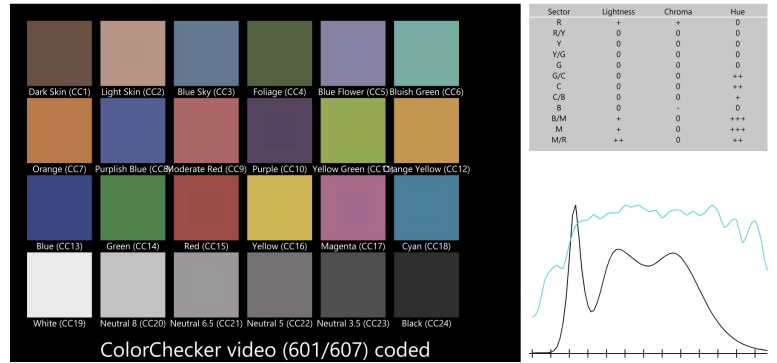

## CQS - NIST Colour Quality Scale

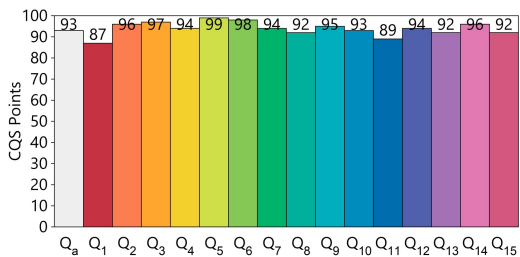

## ANSI/IES TM-30-18 Colour Rendition Report

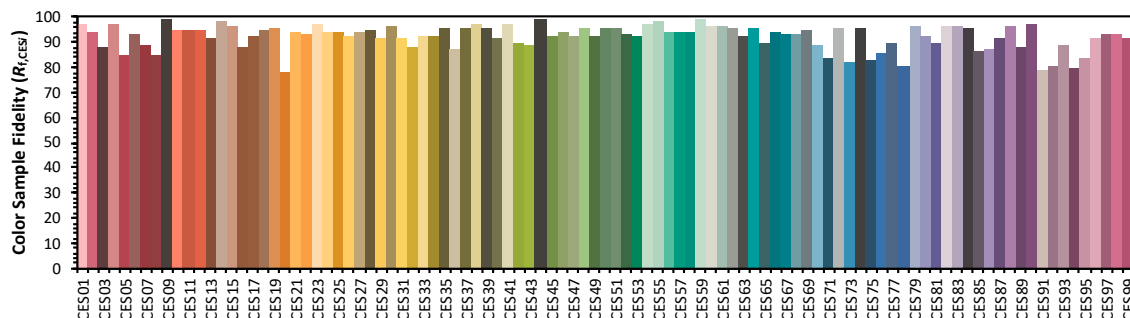
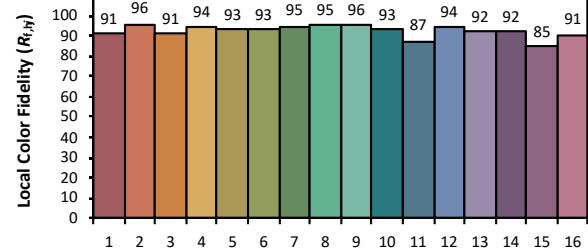
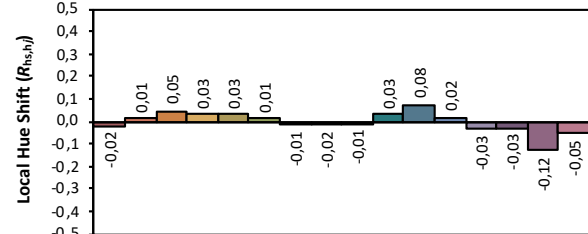
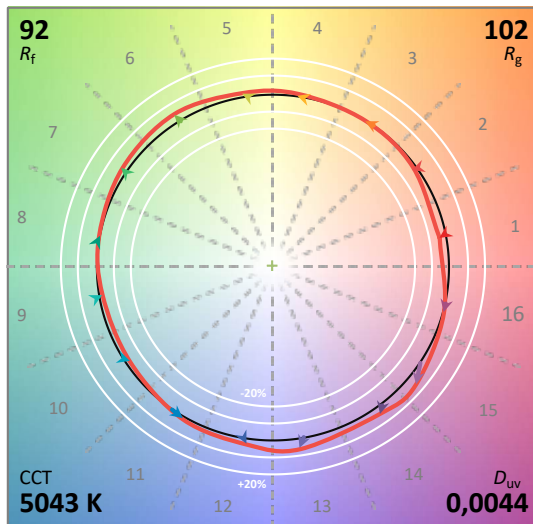
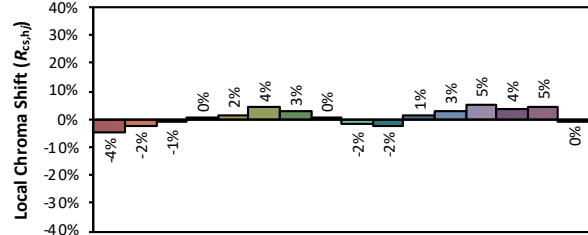
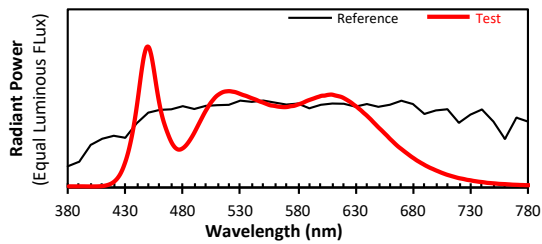

Colours are for visual orientation purposes only. Created with the IES TM-30-18 Calculator Version 2.00